



SERVICE MANUAL **105**



marantz



model 105



Fm / Am



Stereophonic Tuner



TABLE OF CONTENTS

SECTION	PAGE
Introduction	1
AM Tuner	1
FM Tuner	1
AM Alignment Procedure	3
FM Alignment Procedure	3
Test Equipment Required for Servicing	4
Parts List	11~15
Technical Specifications	16

LIST OF ILLUSTRATIONS

FIGURE NO	PAGE
1. Dial Stringing	5
2. Front Panel Adjustments and Component Locations	6
3. Main Chassis Component Locations (Top View)	6
4. Rear Panel Adjustment and Component Locations	7
5. Main Chassis Component Locations (Bottom View)	7
6. FM/AM Tuner Assembly P100 Component Locations	8
7. FM, AM, Mono and Muting Switch Assembly P300 Component Locations	8
8. Power Supply Assembly P400 Component Locations	9
9. Schematic Diagram	10

INTRODUCTION

This service manual was prepared for use by Authorized Warranty Stations and contains service information for Marantz Model 105 Stereophonic Tuner.

Servicing information and voltage data included in this manual are intended for use by the knowledgeable and experienced technician only. All instruction should be read carefully. No attempt should be made to proceed without a good understanding of the operation in the tuner.

The part lists furnish information by which replacement part may be ordered from the Marantz Company. A simple description is included for parts which can be usually be obtained through local suppliers.

The Model 105 is a tuner version of the Marantz's Model 2010 Tuner/Amplifier and almost the same circuitry as used in the Model 2010 is employed except the audio Amplifier, and power supply circuit.

1. AM Tuner

All components except ferrite bar antenna are mounted on a printed circuit board P100.

The AM signals induced in a ferrite bar antenna are applied to the base of converter transistor H113 through a capacitor of C171, while the local oscillator voltage is injected to the emitter of H113 through a capacitor C172. Both AM signals and oscillating voltage are mixed at the base-emitter junction and converted into 455KHz intermediate frequency. The resulting IF signal is applied to the first IF transformer L116 consisting of one ceramic filter and two tuned circuits.

The output of L116 is led to the transistor H104 which in turn apply its output to the transistor of next stage H105. The fully amplified IF output is then applied to the diode H123 to detect audible signal through the detector transformer L117. The detected audio signal is filtered and the final audio output is obtained from pin terminal J118 and applied to the output jacks through the function switch.

The DC component of the detected IF signal is used as a AGC voltage to control emitter current of H104 through the resistor R185. A part of IF signal output is also applied to the diode H124 through a capacitor C180 and rectified to obtain DC current for energizing the AM signal strength meter M001.

1.1 Suggestions for AM Tuner trouble shooting

Check for broken AM bar antenna, next try to tune station by rotating fly-wheel tuning knob slowly and observe the AM signal strength meter whether it deflects or not. If the signal strength meter gives a deflection at several frequencies received, no failure may exist in the stages at least preceding final IF transformer L117. Next connect a oscilloscope to the pin terminal J118 and check for audio signals with the tuning meter deflected. If the signal strength meter does not deflect, check the local oscillator circuit. Normal oscillating voltage at the hot end of the oscillator tuning capacitor is about 2 or 3 volts, varying with tuning capacitor position. When measuring oscillating voltage use a RF VTVM, no circuit tester gives correct indication. If the local oscillator voltage is normal, check all voltage distribution in the AM circuits by using a DC VTVM and compare the measured values with those given in the schematic diagram.

2. FM Tuner

All components are mounted on a printed circuit board P100.

FM signals induced by a FM antenna are led to FM antenna coil L101.

These signals are then applied to the FET RF amplifier which in turn applies its output to the next transistor mixer H102 through a high Q tuned circuit.

The mixer convert its input signal into 10.7MHz intermediate frequency and amplifies it at the same time. The H103 is a local oscillator and its output is injected into the base of mixer transistor, the injection voltage is about 40mV.

The 10.7 MHz front end output is led to the next IF section. The IF section consists of five stage of IF amplifier and one stage of sub IF amplifier. Two pieces of ceramic filters are also used to obtain high selectivity, a pair of symmetrical diode limiters are also employed for the best limiting characteristics, improved capture ratio and good AM suppression. A part of IF amplifier H105 output is rectified by the diode H115, H116 and its DC output is fed back to the gate of FET RF amplifier to decrease the gain with increased signal strength.

2.1 Muting and Auto-Stereo Switching Circuits

The muting circuit consisting of all solid-state electrical switching has been incorporated in the Model 105.

The DC voltage obtained by rectifying the sub IF output signal from the H109 is applied to the base of H110 and turns on it, if the sub IF output is greater than predetermined level (muting threshold level).

When H110 turns on, the muting switch transistor H111 is turned on, thus decreasing the emitter collector resistance to near zero ohm and allowing emitter current path to the Final IF amplifier H108.

When the input signal is lower than the predetermined level, the DC output obtained is small and can not turn on the H110, thus the H110 keeps its turn off state and this makes the switch transistor keep H111 turn off, then no emitter current is supplied to the H108 and signals below the threshold level are muted out.

The muting threshold level can be varied by adjusting the trimming resistor R153.

The DC voltage obtained is also used to make the Auto-Stereo switching transistor H112 turn on and off, and used to energizing the signal strength merer M001.

2.2 MPX Stereo Decoding Circuit

A Non-equalized audio signal from the FM detector is applied through the phase adjuster network of C148 and C161 to input terminal pin ① on the MPX decoder IC H114. The MPX decoder IC consists of a stereo decoder and postamplifier for the output. The right and left channel signals decoded by the stereo decoder H114, appear at pin ⑩ (right channel) and pin ⑪ (left channel), respectively. These signals are passed through the low-pass filters and de-emphasis networks to eliminate undesirable residual switching signals and are then delivered to postamplifier input pin ⑤ (right channel) and pin ⑦ (left channel), respectively. The signals amplified in the postamplifiers to the required level (approximately 10 dB) are delivered to pin ⑥ (right channel) and pin ⑧ (left channel), and are then passed through C169 and C168 to pin terminals J114 and J115, hence, through function switches to the "OUTPUT" terminal. Pin ⑮ on the MPX IC H114 is connected through R163 to the collector of the autostereo switch transistor H112, which turns on or off according to the incoming FM signal strength, thereby automatically switching between the stereophonic and monaural operations. The H112 turns on or off in accordance with whether the FM signal strength is more or less than approximately 25 μ V.

2.3 Suggestion for Trouble Shooting of FM Tuner

2.3.1 Symptom: No FM Reception

First turn on the power switch and try to tune FM stations. Rotate the fly-wheel tuning knob slowly and observe the FM signal strength meter. If the signal strength meter deflect at several frequencies received, the tuner circuits preceding the discriminator circuit may have no failure. When no reading is obtained in the meter, check FM local oscillator circuit, using a RF VTVM.

The normal local oscillator voltage is one or two volts (rms) at the tuning capacitor, depending on the tuning capacitor position. If the local oscillator voltage is normal, next check all voltage distribution in the FM Front End and IF amplifier unit and compare them with those shown in the circuit diagram. When signal strength meter deflects but no sound is obtained, check audio circuits, using high sensitive oscilloscope.

2.3.2 Symptom: No Stereo Separation

First check the "MONO" switch is in normal out position. Connect a FM RF signal generator output modulated by a stereo modulator to the rear FM antenna terminals, and check the stereo beacon is turned on or not. If not turned on, check for 19 KHz pilot signal and 38 KHz switching signal, using an oscilloscope.

3. AM Alignment Procedure

3.1 AM IF Alignment

1. Connect a sweep generator to the test point ① or J107 and an alignment scope to the test point ②.
2. Rotate each core of IF transformer L110 and L117 for maximum height and flat top symmetrical response.

3.2 AM Frequency Range and Tracking Alignment

1. Set AM signal generator to 525 KHz. Turn the tuning capacitor fully closed (place the tuning pointer at the low end.) and adjust the oscillator coil L115 for maximum audio output.
2. Set the signal generator to 1650 KHz. Place the tuning pointer in the high frequency end and adjust the oscillator trimmer on the oscillator tuning capacitor (CA-2) for maximum audio output.
3. Repeat the step 1 and 2 until no further adjustment is necessary.
4. Set the generator to 600 KHz and tune the receiver to the same frequency and adjust a slug core of AM ferrite rod antenna for maximum output.
5. Set the generator to 1400 KHz and tune the receiver to the same frequency and adjust the trimming capacitors of Antenna (CA-1) for maximum output.
6. Repeat the step 4 and 5 until no further adjustment is necessary.

Note: During tracking alignment reduce the signal generator output as necessary to avoid AGC action.

4. FM Alignment Procedure

1. Connect a FM signal generator to the FM antenna terminals and a oscilloscope and an audio distortion analyzer to the tape output jacks on the rear panel.
2. Set the FM SG to 87.5 MHz and provide about 3 to 5 μ V. Place the tuning pointer at the low frequency end by rotating the tuning knob and adjust the core of oscillator coil L103 to obtain maximum audio output.
3. Set the FM SG to 108.5 MHz and provide about 3 to 5 μ V output. Rotate the tuning knob and place the tuning pointer at the high frequency end and adjust the trimming capacitor C187 for Maximum output.
4. Repeat the step 2 and 3 until no further adjustment is necessary.
5. Set the FM SG to 90 MHz and tune the receiver to the same frequency. Decrease signal generator output until the audio output level decreases with the decreasing generator output. Adjust the antenna coil L101, RF coil L102 and IF transformer L105 for minimum audio distortion.
6. Set the FM SG to 106 MHz and tune the receiver to the same frequency. Adjust the trimming capacitor CF-1, CF-2 for minimum distortion.
7. Repeat the step 5 and 6 until no further adjustment is necessary.
8. Connect a DC VTVM with 1 volt range selected to the test point ③ (J120) and adjust the secondary core (upper) of discriminator transformer L107 so that no voltage reading is obtained on the VTVM at no signal.

Next set the FM SG to 98 MHz and increase the output level to 1 K μ V, then tune the receiver to the same frequency so that no deflection is obtained on the VTVM.

Adjust primary core (bottom) of L107 for minimum distortion, and adjust the L108 for the maximum deflection of FM signal strength meter M001.

4.1 STEREO Separation Alignment

1. Set the FM SG to provide 1 K μ V at 98 MHz.

Tune the receiver to the same frequency perfectly (so that the VTVM connected to the test point ⑤ gives no reading).

2. Modulate the FM SG with stereo composite signal consisting of subchanced signal only (of course a pilot signal must be included).

Adjust the core of L110 for maximum audio output, then, modulate the FM SG with a stereo composite signal consisting of L or R channel only, and adjust the trimming resistor R161 for maximum and equal separation in both channels.

4.2 Muting Circuit Alignment

1. Set the FM SG output to provide 25 μ V (IHF) at 98 MHz and tune the receiver to the same frequency.

Adjust the trimming resistor R153 for the threshold level of 25 μ V (during this adjustment turn the MUTING pushswitch "on").

5. Test Equipment Required for Servicing

Table 1 lists the test equipment required for servicing the Model 105 Tuner.

Item	Manufacturer and Model No.	Use
AM Signal Generator		Signal source for AM alignment
Test Loop		Used with AM Signal generator
FM Signal Generator	Less than 0.3% distortion	Signal source for FM alignment
Stereo Modulator	Less than 0.3% distortion	Stereo separation alignment and trouble shooting
Audio Oscillator	Weston Model CVO-100P, less than 0.02% residual distortion is required	Sinewave and squarewaves signal source
Oscilloscope	High sensitivity with DC horizontal and vertical amplifiers	Waveform analysis and Trouble Shooting, and ASO alignment
VTVM	With AC, DC, RF range	Voltage measurements
Circuit Tester		Trouble Shooting

X

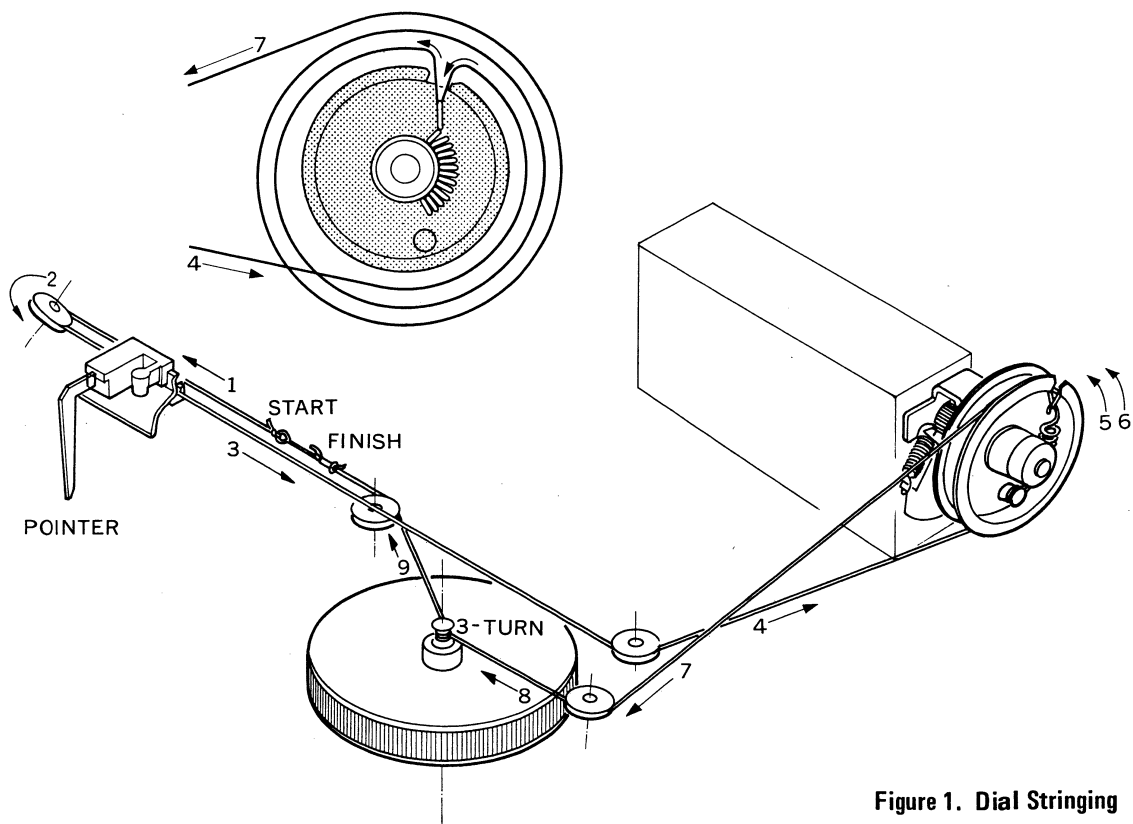

Figure 1. Dial Stringing

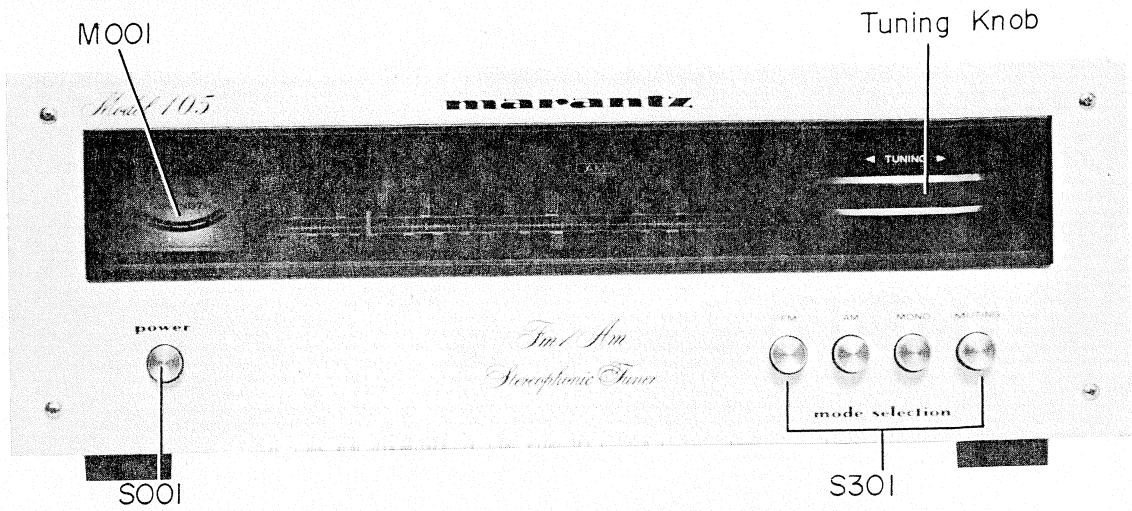

Figure 2. Front Panel Adjustments and Component Locations

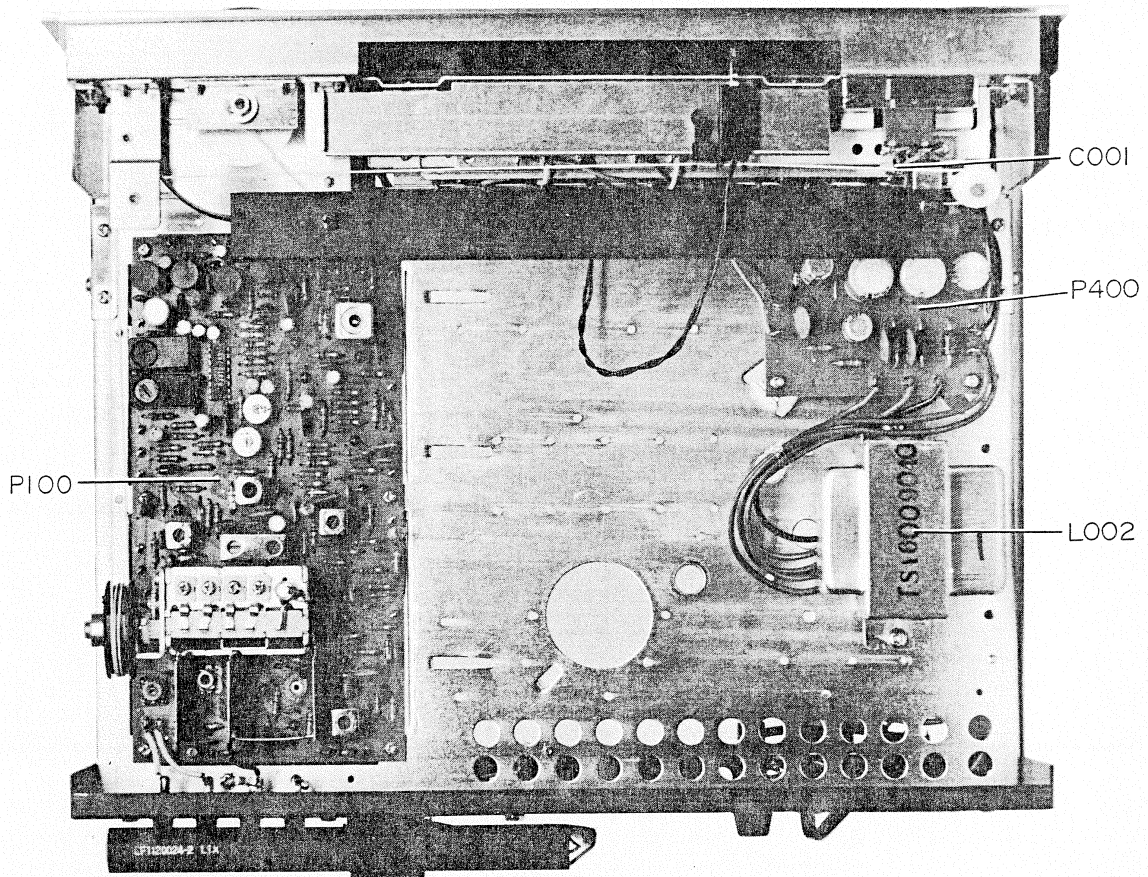

Figure 3. Main Chassis Component Locations (Top View)

X

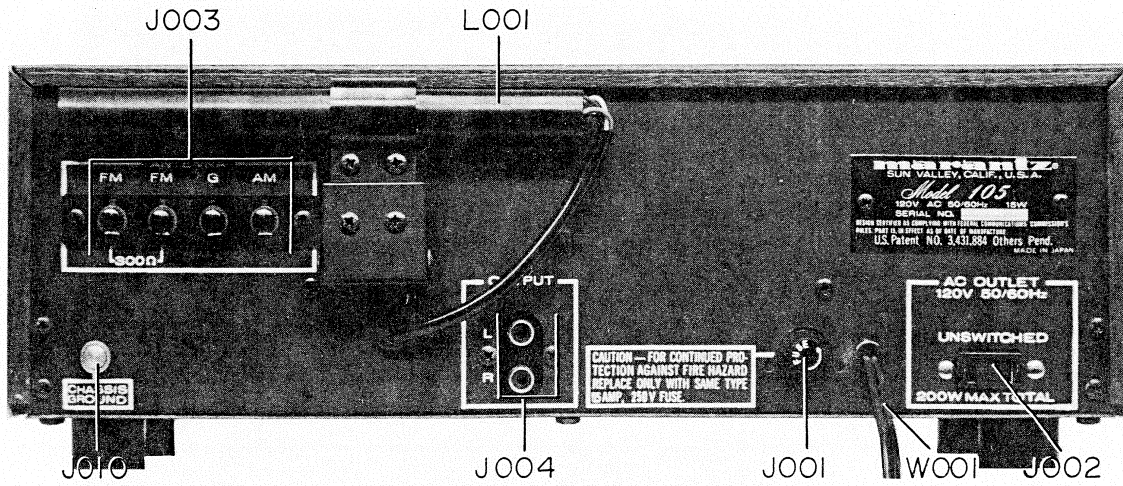

Figure 4. Rear Panel Adjustment and Component Locations

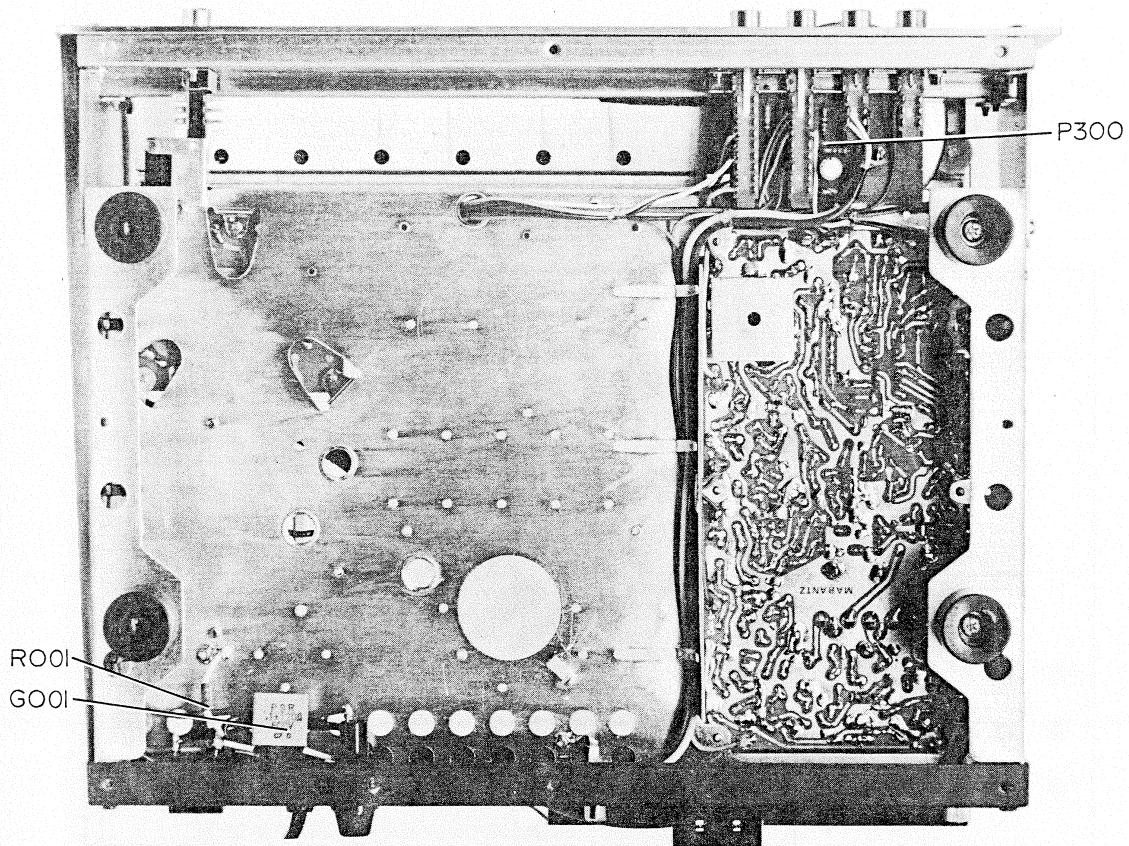

Figure 5. Main Chassis Component Locations (Bottom View)

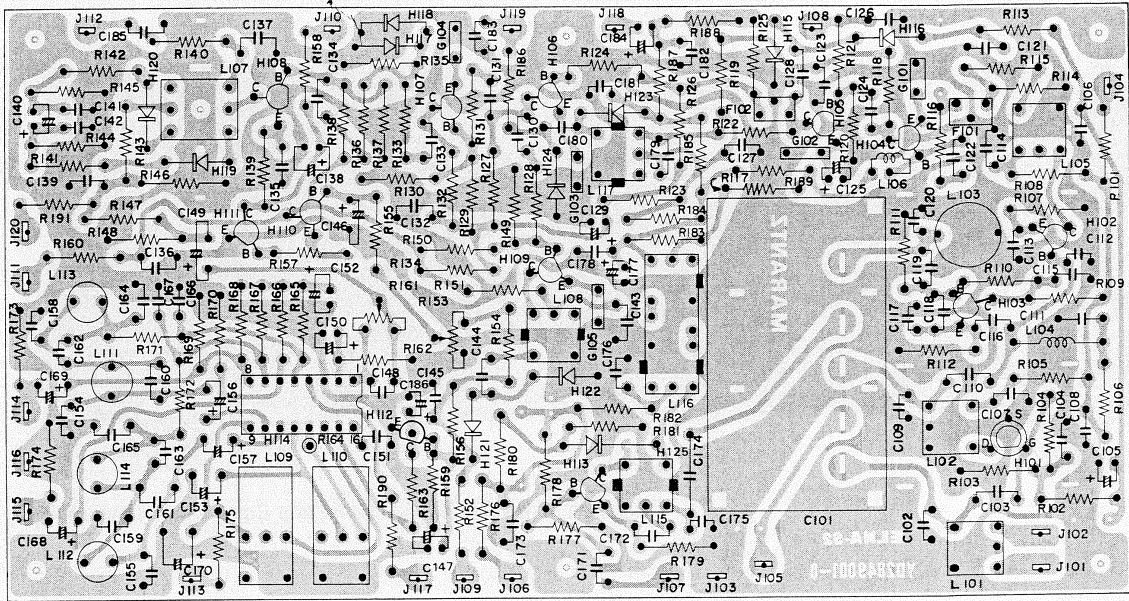

Figure 6. FM/AM Tuner Assembly P100 Component Locations

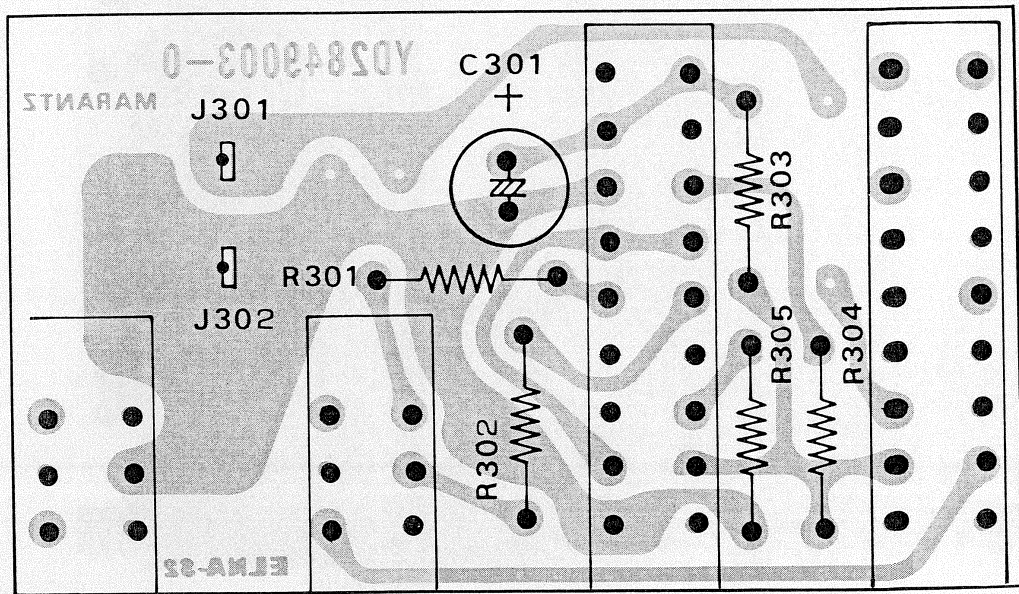

Figure 7. FM, AM, Mono and Muting Switch Assembly P300 Component Locations

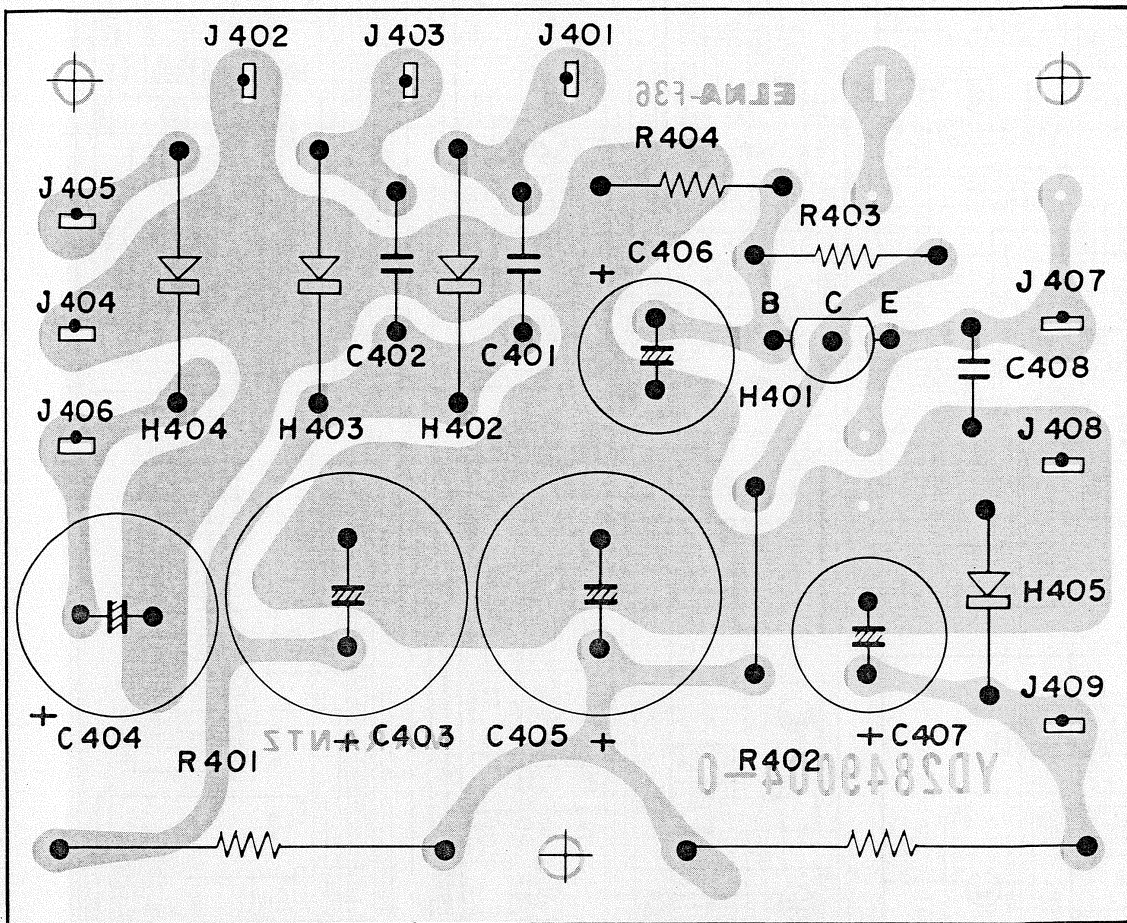
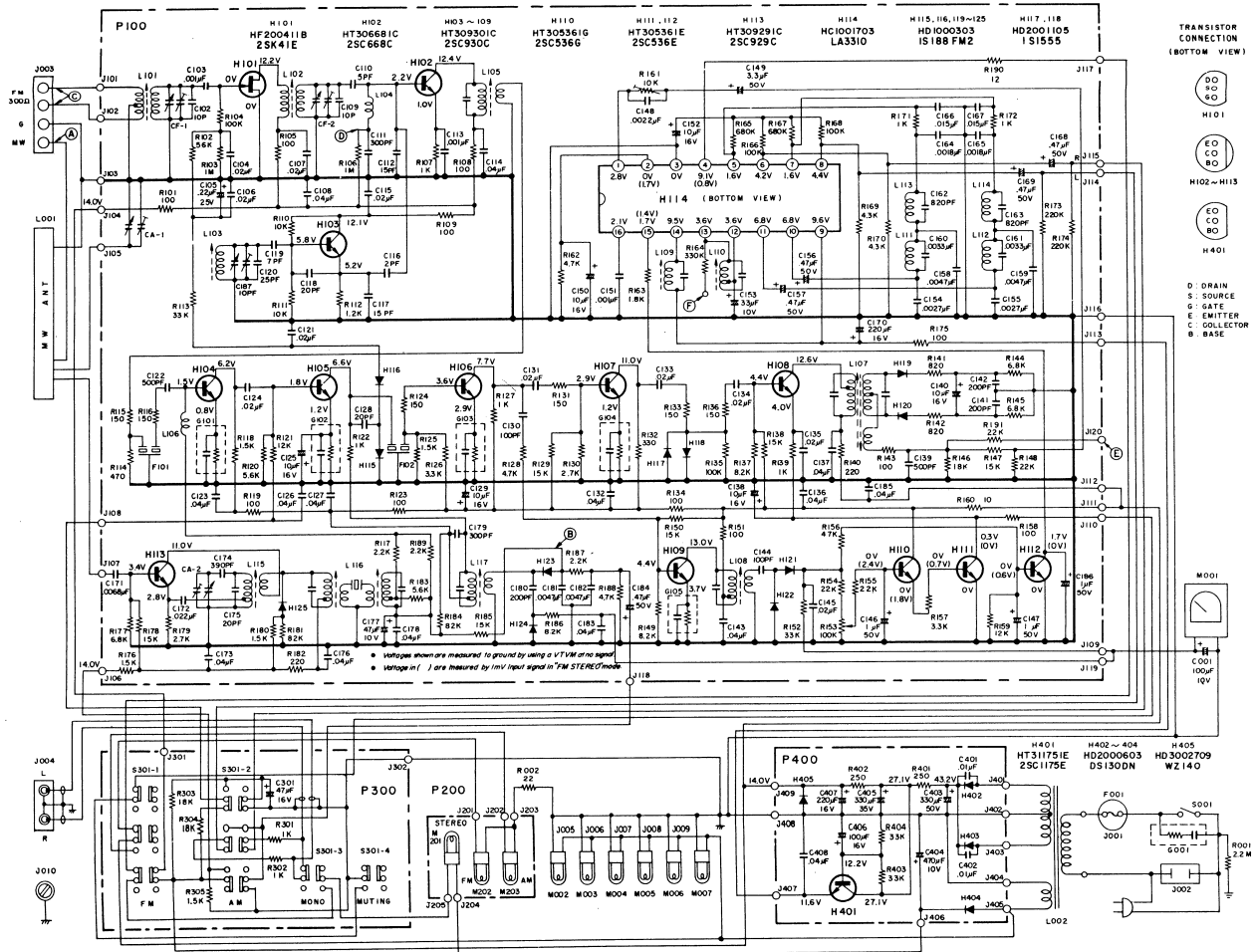

Figure 8. Power Supply Assembly P400 Component Locations



TRANSISTOR CONNECTION (BOTTOM VIEW)

(D) DRAIN
 (S) SOURCE
 (G) GATE
 (E) EMITTER
 (C) COLLECTOR
 (B) BASE

(D) H101
 (E) H102
 (F) H103
 (G) H104
 (H) H105
 (I) H106
 (J) H107
 (K) H108
 (L) H109
 (M) H110
 (N) H111
 (O) H112
 (P) H113
 (Q) H114
 (R) H115
 (S) H116
 (T) H117
 (U) H118

Figure 9. Schematic Diagram

PARTS LIST

REF. DESIG.	PART NO.	DESCRIPTION	REF. DESIG.	PART NO.	DESCRIPTION	
P100	YD2849001 ZZ2849001	P.W. Board Tuner P.W. Board Assembly	R159	RT0512314	12K Ω	
R101	RT0510114	RESISTOR (All resistors are $\pm 5\%$, $\frac{1}{4}$W and carbon type, unless otherwise indicated.)	R160	RT0510014	10 Ω	
R102	RT0556314		100 Ω	R161	RA0103020	Trimming 10K Ω (B)
R103	RT0510514		56K Ω	R162	RT0547214	4.7K Ω
R104	RT0510414		1M Ω	R163	RT0518214	1.8K Ω
R105	RT0510114		100K Ω	R164	RC1033412	Solid 330K $\Omega \pm 10\%$, $\frac{1}{2}$ W
R106	RT0510514		100 Ω	R165	RT0568414	680K Ω
R107	RT0510214		1M Ω	R166	RT0510414	100K Ω
R108	RT0510114		1K Ω	R167	RT0568414	680K Ω
R109	RT0510114		100 Ω	R168	RT0510414	100K Ω
R110	RT0510314		10K Ω	R169	RT0543214	4.3K Ω
R111	RT0510314		10K Ω	R170	RT0543214	4.3K Ω
R112	RT0512214		1.2K Ω	R171	RT0510214	1K Ω
R113	RT0533314	33K Ω	R172	RT0510214	1K Ω	
R114	RT0547114	470 Ω	R173	RT0522414	220K Ω	
R115	RT0515114	150 Ω	R174	RT0522414	220K Ω	
R116	RT0515114	150 Ω	R175	RT0510114	100 Ω	
R117	RT0522214	2.2K Ω	R176	RT0515214	1.5K Ω	
R118	RT0515214	1.5K Ω	R177	RT0568214	6.8K Ω	
R119	RT0510114	100 Ω	R178	RT0515314	15K Ω	
R120	RT0556214	5.6K Ω	R179	RT0527214	2.7K Ω	
R121	RT0512314	12K Ω	R180	RT0515214	1.5K Ω	
R122	RT0510214	1K Ω	R181	RT0582314	82K Ω	
R123	RT0510114	100 Ω	R182	RT0522114	220 Ω	
R124	RT0515114	150 Ω	R183	RT0556214	5.6K Ω	
R125	RT0515214	1.5K Ω	R184	RT0582314	82K Ω	
R126	RT0533214	3.3K Ω	R185	RT0515314	15K Ω	
R127	RT0510214	1K Ω	R186	RT0582214	8.2K Ω	
R128	RT0547214	4.7K Ω	R187	RT0522214	2.2K Ω	
R129	RT0515314	15K Ω	R188	RT0547214	4.7K Ω	
R130	RT0527214	2.7K Ω	R189	RT0522214	2.2K Ω	
R131	RT0515114	150 Ω	R190	RT0512014	12 Ω	
R132	RT0533114	330 Ω	R191	RT0522314	22K Ω	
R133	RT0515114	150 Ω			CAPACITORS	
R134	RT0510114	100 Ω	C101	CA3240007	Variable FM-3, AM-2 GANG	
R135	RT0510414	100K Ω	C102	DD1210001	Ceramic 10pF $\pm 10\%$	
R136	RT0515114	150 Ω	C103	DK1710201	Ceramic 0.001 μ F $\pm 20\%$	
R137	RT0582214	8.2K Ω	C104	DK1820302	Ceramic 0.02 μ F $^{+100\%}_{-0}$	
R138	RT0515314	15K Ω	C105	EM2240251	Electroly 0.22 μ F 25V	
R139	RT0510214	1K Ω	C106	DK1820302	Ceramic 0.02 μ F $^{+100\%}_{-0}$	
R140	RT0522114	220 Ω	C107	DK1820302	Ceramic 0.02 μ F $^{+100\%}_{-0}$	
R141	RT0582114	820 Ω	C108	DK1840302	Ceramic 0.04 μ F $^{+80\%}_{-20}$	
R142	RT0582114	820 Ω	C109	DD1210001	Ceramic 10pF $\pm 10\%$	
R143	RT0510114	100 Ω	C110	DD1105001	Ceramic 5pF ± 0.5 pF	
R144	RT0568214	6.8K Ω	C111	DD1530101	Ceramic 300pF $\pm 5\%$	
R145	RT0568214	6.8K Ω	C112	DD1615003	Ceramic 15pF $\pm 10\%$	
R146	RT0518314	18K Ω	C113	DK1710201	Ceramic 0.001 μ F $\pm 20\%$	
R147	RT0515314	15K Ω	C114	DK1840302	Ceramic 0.04 μ F $^{+80\%}_{-20}$	
R148	RT0522314	22K Ω	C115	DK1820302	Ceramic 0.02 μ F $^{+100\%}_{-0}$	
R149	RT0582214	8.2K Ω	C116	DD1102004	Ceramic 2pF ± 0.5 pF	
R150	RT0515314	15K Ω	C117	DD1615003	Ceramic 15pF $\pm 10\%$	
R151	RT0510114	100 Ω	C118	DD1520001	Ceramic 20pF $\pm 5\%$	
R152	RT0533314	33K Ω	C119	DD1207003	Ceramic 7pF ± 1 pF	
R153	RA0104015	Trimming 100K Ω (B)	C120	DD1525002	Ceramic 25pF $\pm 5\%$	
R154	RT0522314	22K Ω				
R155	RT0522314	22K Ω				
R156	RT0547314	47K Ω				
R157	RT0533214	3.3K Ω				
R158	RT0510114	100 Ω				

REF. DESIG.	PART NO.	DESCRIPTION	
C121	DK1820302	Ceramic	0.02 μ F ^{+100%} ₋₀
C122	DD1650101	Ceramic	500pF \pm 10%
C123	DK1840302	Ceramic	0.04 μ F ^{+80%} ₋₂₀
C124	DK1820302	Ceramic	0.02 μ F ^{+100%} ₋₀
C125	EA1060169	Electroly	10 μ F 16V
C126	DK1840302	Ceramic	0.04 μ F ^{+80%} ₋₂₀
C127	DK1840302	Ceramic	0.04 μ F ^{+80%} ₋₂₀
C128	DD1620001	Ceramic	20pF \pm 10%
C129	EA1060169	Electroly	10 μ F 16V
C130	DD1610101	Ceramic	100pF \pm 10%
C131	DK1820302	Ceramic	0.02 μ F ^{+100%} ₋₀
C132	DK1840302	Ceramic	0.04 μ F ^{+80%} ₋₂₀
C133	DK1820302	Ceramic	0.02 μ F ^{+100%} ₋₀
C134	DK1820302	Ceramic	0.02 μ F ^{+100%} ₋₀
C135	DK1820302	Ceramic	0.02 μ F ^{+100%} ₋₀
C136	DK1840302	Ceramic	0.04 μ F ^{+80%} ₋₂₀
C137	DK1840302	Ceramic	0.04 μ F ^{+80%} ₋₂₀
C138	EA1060169	Electroly	10 μ F 16V
C139	DD1650101	Ceramic	500pF \pm 10%
C140	EA1060169	Electroly	10 μ F 16V
C141	DD1620101	Ceramic	200pF \pm 10%
C142	DD1620101	Ceramic	200pF \pm 10%
C143	DK1840302	Ceramic	0.04 μ F ^{+80%} ₋₂₀
C144	DD1610101	Ceramic	100pF \pm 10%
C145	DK1820302	Ceramic	0.02 μ F ^{+100%} ₋₀
C146	EA1050509	Electroly	1 μ F 50V
C147	EA1050509	Electroly	1 μ F 50V
C148	DF1722201	Film	0.0022 μ F \pm 20%
C149	EA3350509	Electroly	3.3 μ F 50V
C150	EA1060169	Electroly	10 μ F 16V
C151	DF1610201	Film	0.001 μ F \pm 10%
C152	EA1060169	Electroly	10 μ F 16V
C153	EA3360109	Electroly	33 μ F 10 V
C154	DF1627201	Film	0.0027 μ F \pm 10%
C155	DF1627201	Film	0.0027 μ F \pm 10%
C156	EA4740501	Electroly	0.47 μ F 50V
C157	EA4740501	Electroly	0.47 μ F 50V
C158	DF1647201	Film	0.0047 μ F \pm 10%
C159	DF1647201	Film	0.0047 μ F \pm 10%
C160	DF1533205	Film	0.0033 μ F \pm 5%
C161	DF1533205	Film	0.0033 μ F \pm 5%
C162	DF5582101	Film	820pF \pm 5%
C163	DF5582101	Film	820pF \pm 5%
C164	DF1618205	Film	0.0018 μ F \pm 10%
C165	DF1618205	Film	0.0018 μ F \pm 10%
C166	DF1615301	Film	0.015 μ F \pm 10%
C167	DF1615301	Film	0.015 μ F \pm 10%
C168	EA4740501	Electroly	0.47 μ F 50V
C169	EA4740501	Electroly	0.47 μ F 50V
C170	EA2270169	Electroly	220 μ F 16V

REF. DESIG.	PART NO.	DESCRIPTION	
C171	DF1768201	Film	0.0068 μ F \pm 20%
C172	DF1722301	Film	0.022 μ F \pm 20%
C173	DF1740301	Film	0.04 μ F \pm 20%
C174	DF6539101	Film	390pF \pm 5%
C175	DD1620001	Ceramic	20pF \pm 10%
C176	DF1740301	Film	0.04 μ F \pm 20%
C177	EA4760109	Electroly	47 μ F 10V
C178	DK1840302	Ceramic	0.04 μ F ^{+80%} ₋₂₀
C179	DD1530101	Ceramic	300pF \pm 5%
C180	DD1620101	Ceramic	200pF \pm 10%
C181	DF1647201	Film	0.0047 μ F \pm 10%
C182	DF1647201	Film	0.0047 μ F \pm 10%
C183	DK1840302	Ceramic	0.04 μ F ^{+80%} ₋₂₀
C184	EA4740501	Electroly	0.47 μ F 50V
C185	DK1840302	Ceramic	0.04 μ F ^{+80%} ₋₂₀
C186	EA1050509	Electroly	1 μ F 50V
C187	CT1100008	Trimming	10pF
MISCELLANEOUS			
G101	BF4030001	Printed Compo.	0.04 μ F +270 Ω
G102	BF2230008	Printed Compo.	0.022 μ F +270 Ω
G103	BF2230007	Printed Compo.	0.022 μ F +680 Ω
G104	BF2230006	Printed Compo.	0.022 μ F +1K Ω
G105	BF2230006	Printed Compo.	0.022 μ F +1K Ω
F101	FF1107004	Ceramic Filter	CFS107M
F102	FF1107004	Ceramic Filter	CFS107M
COILS AND TRANSFORMERS			
L101	LA1004606	Ant Coil	FM
L102	LA1027809	RF Coil	FM
L103	LO1203601	OSC Coil	FM
L104	LC1751001	Choke Coil	0.75 μ H
L105	LI1001601	IFT	FM
L106	LC1223002	Choke Coil	22 μ H
L107	LI1401623	IFT	FM
L108	LI1015602	IFT	FM
L109	LS1031001	MPX Coil	19KHz
L110	LS1031004	MPX Coil	38KHz
L111	LC2226004	Choke Coil	22mH
L112	LC2226004	Choke Coil	22mH
L113	LC2226004	Choke Coil	22mH
L114	LC2226004	Choke Coil	22mH
L115	LO1001042	OSC Coil	AM
L116	LI1028002	IFT	AM
L117	LI1001048	IFT	AM
SEMICONDUCTORS			
H101	HF200411B	FET	2SK41E
H102	HT306681C	Transistor	2SC668C
H103	HT309301C	Transistor	2SC930C
H104	HT309301C	Transistor	2SC930C
H105	HT309301C	Transistor	2SC930C
H106	HT309301C	Transistor	2SC930C
H107	HT309301C	Transistor	2SC930C
H108	HT309301C	Transistor	2SC930C
H109	HT309301C	Transistor	2SC930C
H110	HT305361G	Transistor	2SC536G
H111	HT305361E	Transistor	2SC536E
H112	HT305361E	Transistor	2SC536E

REF. DESIG.	PART NO.	DESCRIPTION	
H113	HT309291C	Transistor	2SC929C
H114	HC1001703	IC	LA3310
H115	HD1000303	Diode	1S188FM2
H116	HD1000303	Diode	1S188FM2
H117	HD2001105	Diode	1S1555
H118	HD2001105	Diode	1S1555
H119	HD1000303	Diode	1S188FM2
H120	HD1000303	Diode	1S188FM2
H121	HD1000303	Diode	1S188FM2
H122	HD1000303	Diode	1S188FM2
H123	HD1000303	Diode	1S188FM2
H124	HD1000303	Diode	1S188FM2
H125	HD1000303	Diode	1S188FM2
MISCELLANEOUS			
J101	YP1000099	Plug	
J102	YP1000099	Plug	
J103	YP1000099	Plug	
J104	YP1000099	Plug	
J105	YP1000099	Plug	
J106	YP1000099	Plug	
J107	YP1000099	Plug	
J108	YP1000099	Plug	
J109	YP1000099	Plug	
J110	YP1000099	Plug	
J111	YP1000099	Plug	
J112	YP1000099	Plug	
J113	YP1000099	Plug	
J114	YP1000099	Plug	
J115	YP1000099	Plug	
J116	YP1000099	Plug	
J117	YP1000099	Plug	
J118	YP1000099	Plug	
J119	YP1000099	Plug	
J120	YP1000099	Plug	
O906	282110901	Shield	
O907	286710901	Shield	
O908	285010902	Shield	
1110	62031650W	Lug	
P400	YD2849004 ZZ2849004	P.W. Board P.W. Board Assembly	Power
RESISTORS			
R401	GJ1025102	Oxide	250Ω±10%2W
R402	GJ1025102	Oxide	250Ω±10%2W
R403	RT0533314	Carbon	33KΩ±5%¼W
R404	RT0533314	Carbon	33KΩ±5%¼W
CAPACITORS			
C401	DK1810351	Ceramic	0.01μF ^{+100%} ₋₀ 500V
C402	DK1810351	Ceramic	0.01μF ^{+100%} ₋₀ 500V
C403	EA3370509	Electroly	330μF 50V
C404	EA4770109	Electroly	470μF 10V
C405	EA3370359	Electroly	330μF 35V
C406	EA1070169	Electroly	100μF 16V
C407	EA2270169	Electroly	220μF 16V
C408	DK1840301	Ceramic	0.04μF ^{+100%} ₋₀ 50V

REF. DESIG.	PART NO.	DESCRIPTION	
SEMICONDUCTORS			
H401	HT311751E	Transistor	2SC1175E
H402	HD2000603	Diode	DS130DN
H403	HD2000603	Diode	DS130DN
H404	HD2000603	Diode	DS130DN
H405	HD3002709	Diode	WZ140
MISCELLANEOUS			
J401	YP1000099	Plug	
J402	YP1000099	Plug	
J403	YP1000099	Plug	
J404	YP1000099	Plug	
J405	YP1000099	Plug	
J406	YP1000099	Plug	
J407	YP1000099	Plug	
J408	YP1000099	Plug	
J409	YP1000099	Plug	
O404	282716002	Bracket	
O405	282711202	Shaft	
O406	282711203	Shaft	
O408	285020101	Partitioner	
O409	285016003	Bracket	
O410	285016004	Bracket	
O412	285012201	Sticker	
O421	257710602	Bearing	
O422	141511801	Spacer	
O508	285016007	Bracket	
O509	173011203	Shaft	
O510	257726201	Pulley	
O517	282711801	Spacer	
O611	51040306A	F.H.M. Screw	
O615	51100306A	B.H.M. Screw	
O618	51100306A	B.H.M. Screw	
O621	51100306A	B.H.M. Screw	
O623	51100306A	B.H.M. Screw	
O625	51100306A	B.H.M. Screw	
O626	51100306A	B.H.M. Screw	
P300	YD2849003 ZZ2849003	P.W. Board P.W. Board Assembly	
RESISTORS			
R301	RT0510214	Carbon	1KΩ±5%¼W
R302	RT0510214	Carbon	1KΩ±5%¼W
R303	RT0518314	Carbon	18KΩ±5%¼W
R304	RT0518314	Carbon	18KΩ±5%¼W
R305	GT0515212	Carbon	1.5KΩ±5%¼W
MISCELLANEOUS			
C301	EA4760169	Electroly	47μF 16V
S301	SP0604003	Pushswitch	Band Selector
J301	YP1000099	Plug	
J302	YP1000099	Plug	
S001	SP0301001	Pushswitch	
M001	IM1104203	DC Meter	Signal Strength
C001	EA1070109	Electroly	100μF 10V
O417	285011801	Spacer	

REF. DESIG.	PART NO.	DESCRIPTION
0501	285016009	Bracket
0503	263711203	Shaft
0505	257726201	Pulley
0502	285016008	Bracket
1436	263711203	Shaft
1437	257726201	Pulley
0414	281827101	Holder
0631	51570306B	P.H. Tapt Screw
J005	YJ0800013	Socket
J006	YJ0800013	Socket
J007	YJ0800013	Socket
J008	YJ0800013	Socket
J009	YJ0800013	Socket
M002	IN1008007	Lamp
M003	IN1008007	Lamp
M004	IN1008007	Lamp
M005	IN1008007	Lamp
M006	IN1008007	Lamp
0415	282716003	Bracket
0518	282710701	Sheet
P200	YD2849002 ZZ2849002	P.W. Board P.W. Board Assembly
MISCELLANEOUS		
M201	IN1006301	Lamp 6.3V 40mA
M202	IN1006301	Lamp 6.3V 40mA
M203	IN1006301	Lamp 6.3V 40mA
R002	RC1022012	Resistor Solid 22Ω±10%½W
J201	YP1000099	Plug
J202	YP1000099	Plug
J203	YP1000099	Plug
J204	YP1000099	Plug
J205	YP1000099	Plug
0413	282727401	Reflector
0619	51570306B	P.H. Tapt Screw
0630	51570305B	P.H. Tapt Screw
0418	282705101	Guide
E	284916040	Bracket Assembly
0202	284926501	Indicator
0703	284916001	Bracket
0816	53110403E	Hexagon Nut
0818	54020401E	Flat Washer P
0819	54050400R	T.L. Washer OR
0821	55060307F	T.R. Rivet
0822	54050300R	T.L. Washer OR
0824	51100306S	B.H.M. Screw
0826	51100308S	B.H.M. Screw
0827	53110303E	Hexagon Nut
0832	51100308S	B.H.M. Screw
0833	53110303E	Hexagon Nut
J002	YJ0400018	Jack AC Outlet
J003	YJ0104004	Terminal Ant.
J004	YT0202007	Terminal Output
J010	YL0301021	Terminal Ground
0704	284916021	Bracket

REF. DESIG.	PART NO.	DESCRIPTION
0705	284916022	Bracket
0706	284916023	Bracket
0707	284916024	Bracket
0718	145525903	Bush
0723	282125901	Bush
0725	284906701	Cap
0727	284906702	Cap
0814	51100306S	B.H.M. Screw
0828	53110303A	Hexagon Nut
0829	54050300R	T.L. Washer OR
0830	51060316A	F.H.M. Screw
0831	55060305F	T.R. Rivet
W001	YC0240010	AC Cord
G001	BF1040001	Printed Comp.
F001	FS1005007	Fuse 0.5A
L001	LF1120024	Ant Coil
0711	257816005	Bracket
0712	257816006	Bracket
0713	550203041	S.H. Rivet
0714	281927103	Holder
0806	51100308S	B.H. M. Screw
0807	54050300R	T.L. Washer OR
0808	53110303E	Hexagon Nut
0810	51100310S	B.H. M. Screw
0811	53110303E	Hexagon Nut
R001	GT0522512	Resistor 2.2MΩ±5% ½W
1133	62031650W	Lug
0903	282715901	Drum
0904	71101569M	Spring
0915	51650304D	Set Screw H.P.
B	284927340	Fly Wheel Assembly
0427	257706302	Escutcheon
0429	257727301	Fly Wheel
0431	285011201	Shaft
0432	285011202	Shaft
0607	53110603E	Hexagon Nut
0608	54040602N	Spring Washer
0609	54020601E	Flat Washer P
D	285010340	Pointer Assembly
0526	281810301	Pointer
0527	285010301	Pointer
0528	281805301	Cover
M007	IN1008018	Lamp
C	285000640	Dial String Assembly
0512	120225801	Hook
0513	72080802A	String
0635	56382540G	Eyelet

REF. DESIG.	PART NO.	DESCRIPTION
A	284906340	Escutcheon Assembly
0103	284906301	Escutcheon
0104	282740101	Frame
0105	282715801	Window
0106	281825905	Bush
0108	284905301	Cover
W002	YW2849001	Wire Material
W003	YX2849001	Wire Material
0121	275905701	Leg
0310	51100410A	B.H.M. Screw
0311	54020401A	Flat Washer P
0312	54040402A	Spring Washer
1026	285010501	Chassis
1033	138200503	Clamper
1103	51570408B	P.H. Tapt Screw
1104	54040402N	Spring Washer
1108	51570306B	P.H. Tapt Screw
1113	51570306B	P.H. Tapt Screw
1122	51570306B	P.H. Tapt Screw
1124	51100306S	B.H.M. Screw
1126	51570306B	P.H. Tapt Screw
1127	54050300R	T.L. Washer OR
1128	59030805P	Washer
1131	51570306B	P.H. Tapt Screw
1132	54050300R	T.L. Washer OR
1135	54050300R	T.L. Washer OR
1117	53110303E	Hexagon Nut
1112	51570310B	P.H. Tapt Screw
L002	TS1600904	Power Transf. 120V
0112	281815401	Knob
0118	284925701	Lid
0119	257711803	Spacer
0120	282825702	Lid

REF. DESIG.	PART NO.	DESCRIPTION
0211	257886101	Label UL Caution
0212	257886102	Label Do Not Remove Cover
0213	257886103	Label See Marking on Bottom
0214	250626506	Indicator Do Not Use As Handle
0302	51122608E	T.H.M. Screw
0304	51100406S	B.H.M. Screw
0306	51100406S	B.H.M. Screw
0307	54020401S	Flat Washer
0424	257710601	Bearing
0425	281810601	Bearing
0433	281912002	Insulator
0521	284930201	Dial
0523	282705302	Cover
0532	282626901	Protector
0603	51640412S	Set Screw C.P.
0604	54040402N	Spring Washer
0605	53110403E	Hexagon Nut
0634	51100306S	B.H.M. Screw
0613	51100306A	B.H.M. Screw
0614	54050300R	T.L. Washer OR
2236	138200503	Clamper

TECHNICAL SPECIFICATIONS

FM SECTION:

Tuning Frequency Range	88-108 MHz
IHF M Usable Sensitivity	3.0 μ V
IHF M Selectivity	50dB
Capture Ratio	2.5dB
Image Rejection Ratio at 106MHz	50dB
Signal to Noise Ratio (Mono)	65dB
Signal to Noise Ratio (Stereo)	55dB
Total Harmonic Distortion (Mono)	0.2%
Total Harmonic Distortion (Stereo)	0.5%
Frequency Response (ref. 75 μ sec. de-emphasis)	\pm 1dB, 50 Hz-15KHz
Stereo Separation at 1KHz	40dB

AM SECTION:

Tuning Frequency Range	540-1600KHz
Usable Sensitivity	20 μ V
Selectivity	20dB
Image Rejection Ratio at 1400 KHz	40dB
Signal to Noise Ratio	43dB
Frequency Response, -3dB down	50Hz-4KHz
Total Harmonic Distortion	1%

GENERAL:

Power Requirements	120V AC 50 to 60 Hz
Power Consumption	15 Watts
Dimensions Panel Width	14-11/64
Panel Height	4-23/32
Depth	11-1/32
Weight Unit alone	13.2 lbs
Packed for Shipment	25.5 lbs

*These specifications and exterior designs may be changed for improvement without advance notice.